

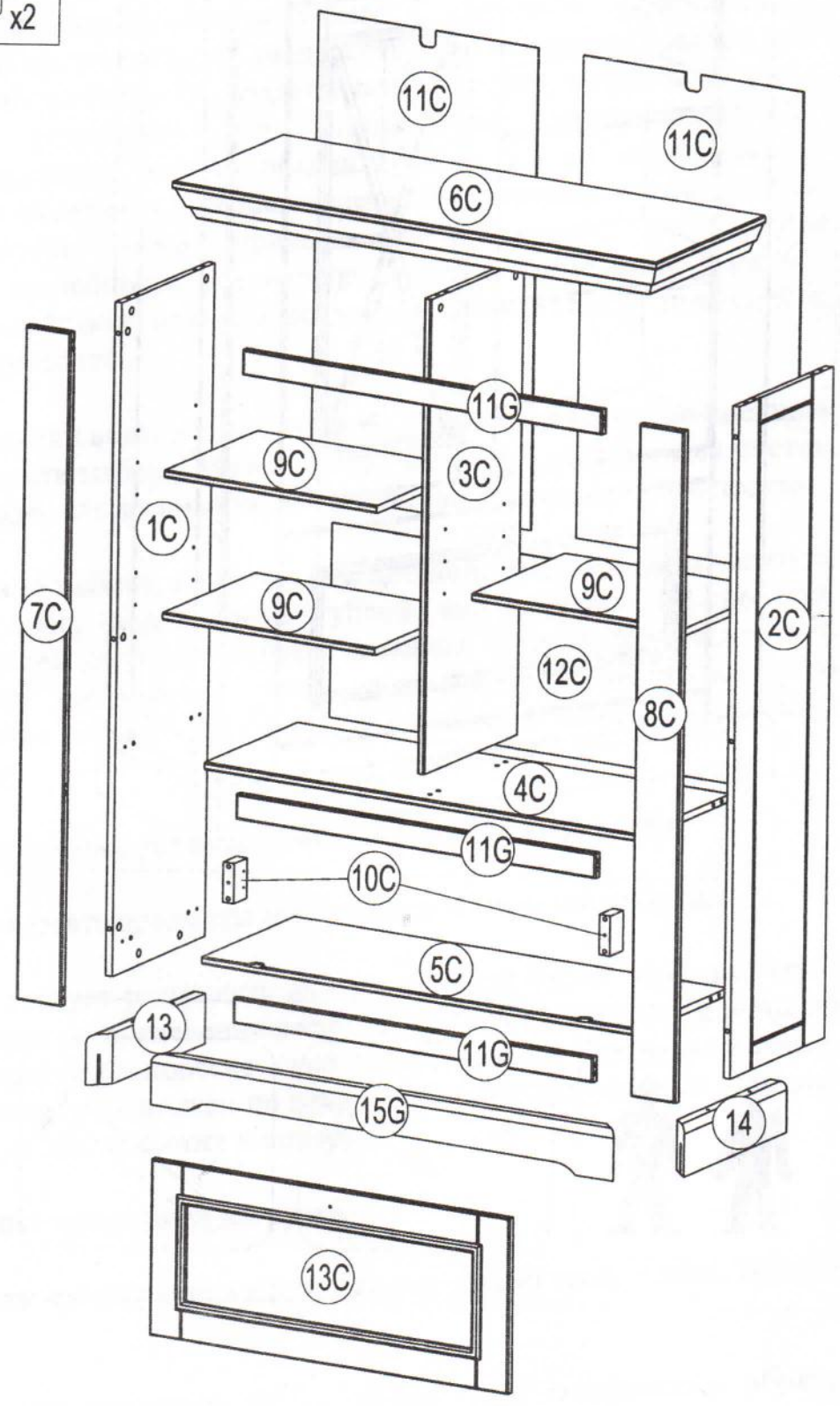

180 min

EAC

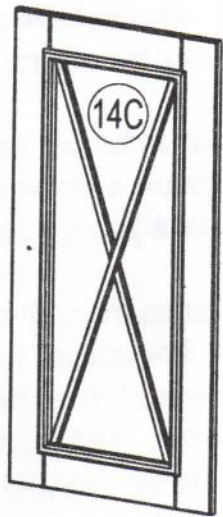
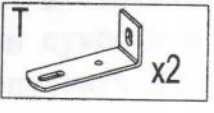
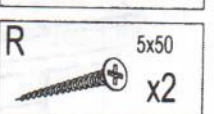
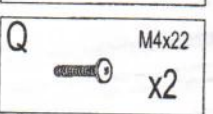
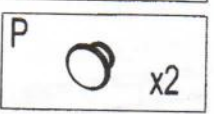
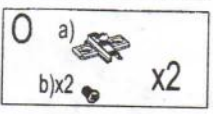
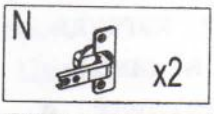
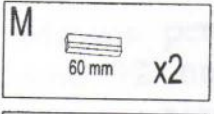
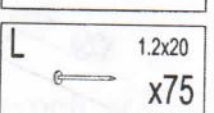
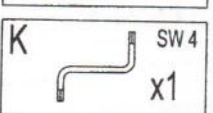
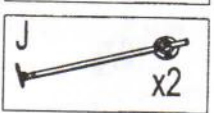
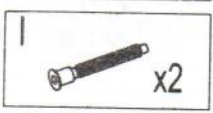
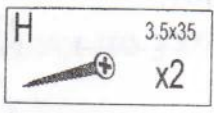
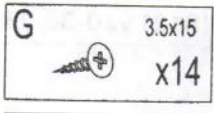
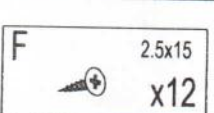
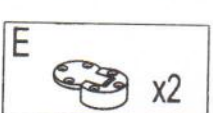
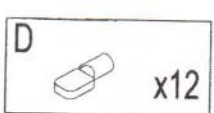
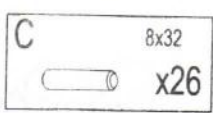
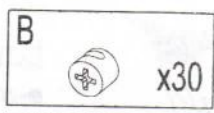
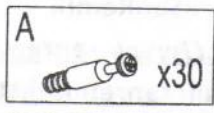

1

A  x14

C  8x32 x22

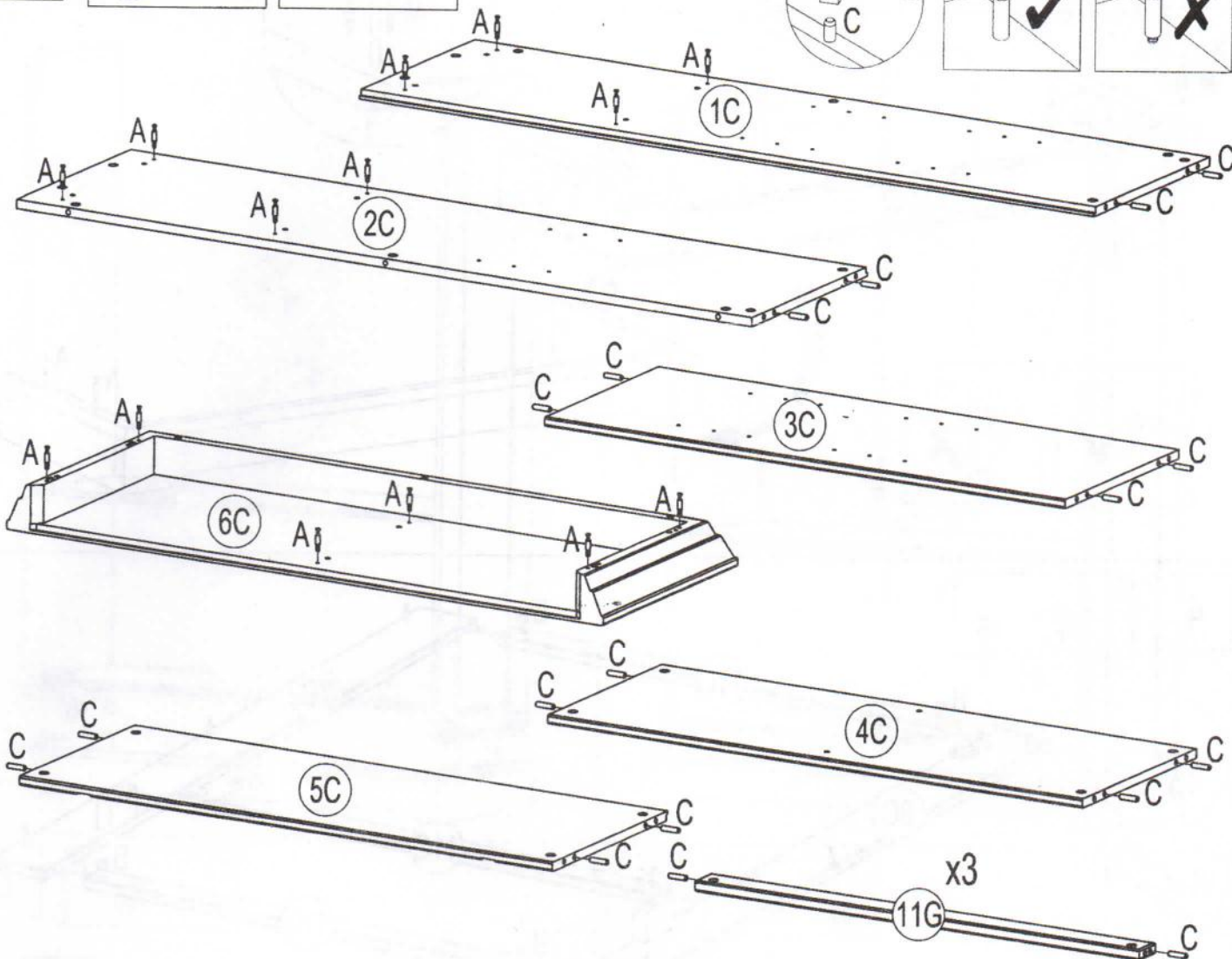
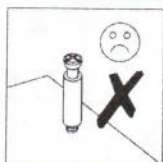
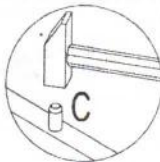



2

A  x12

C  8x32 x4

H  3.5x35 x2

O a)  x2
b)  x2

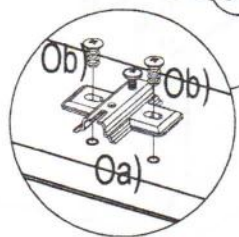
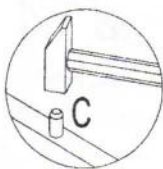
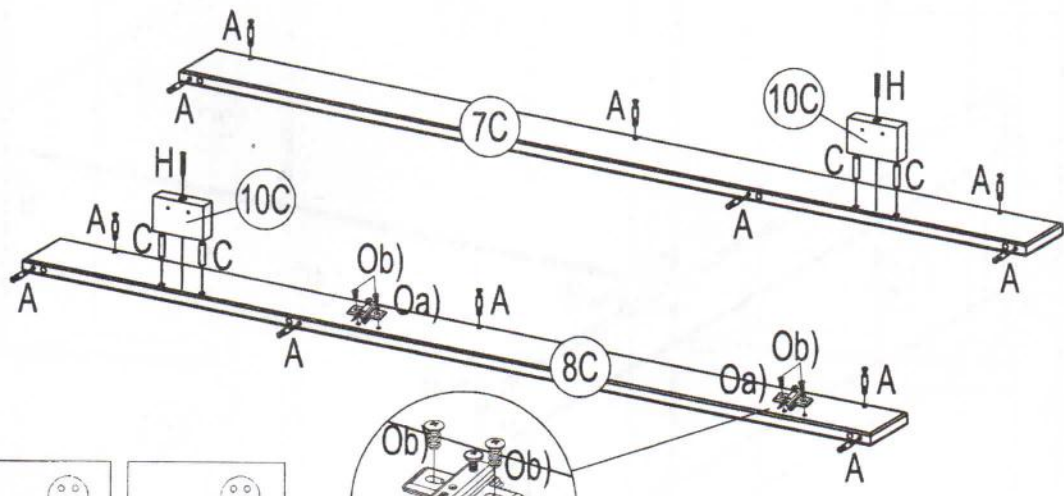

3

3

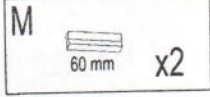
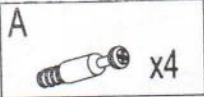

M

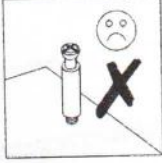
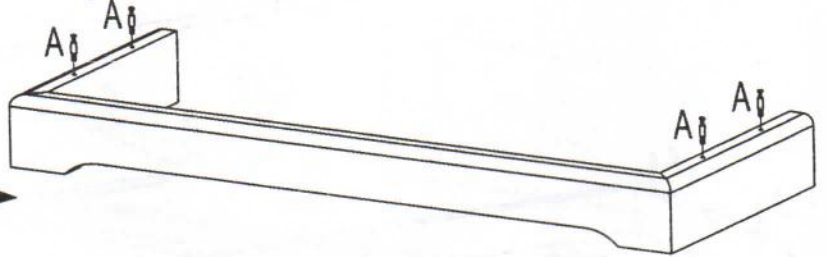
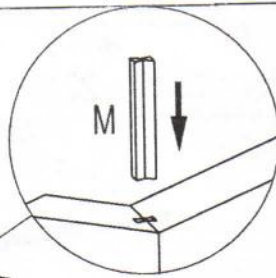
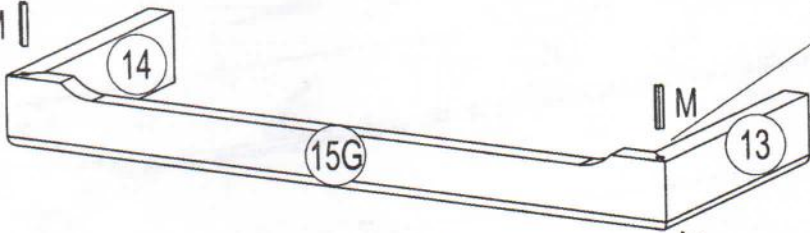

4

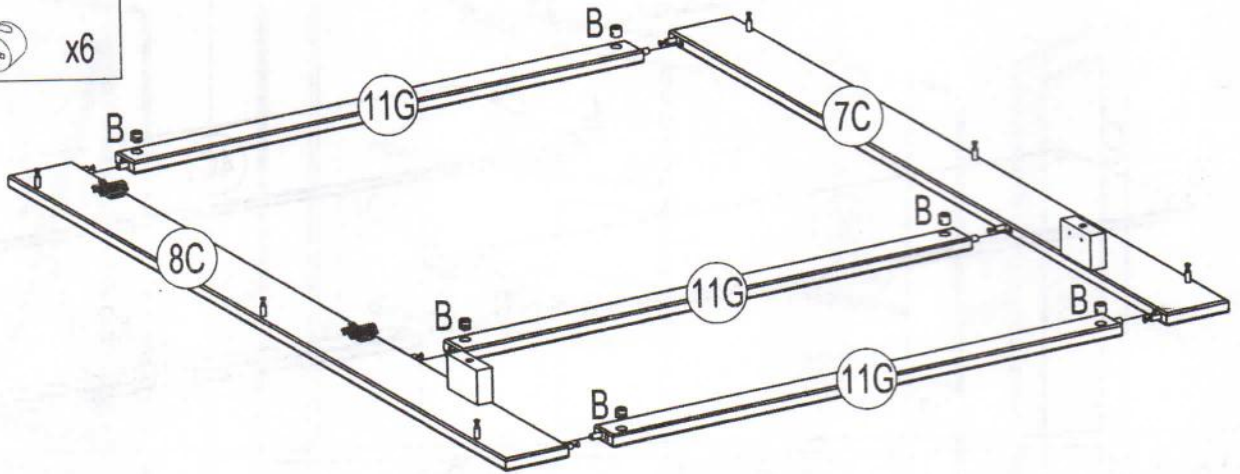
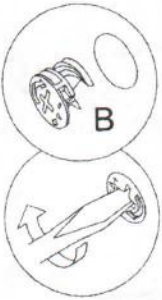

5

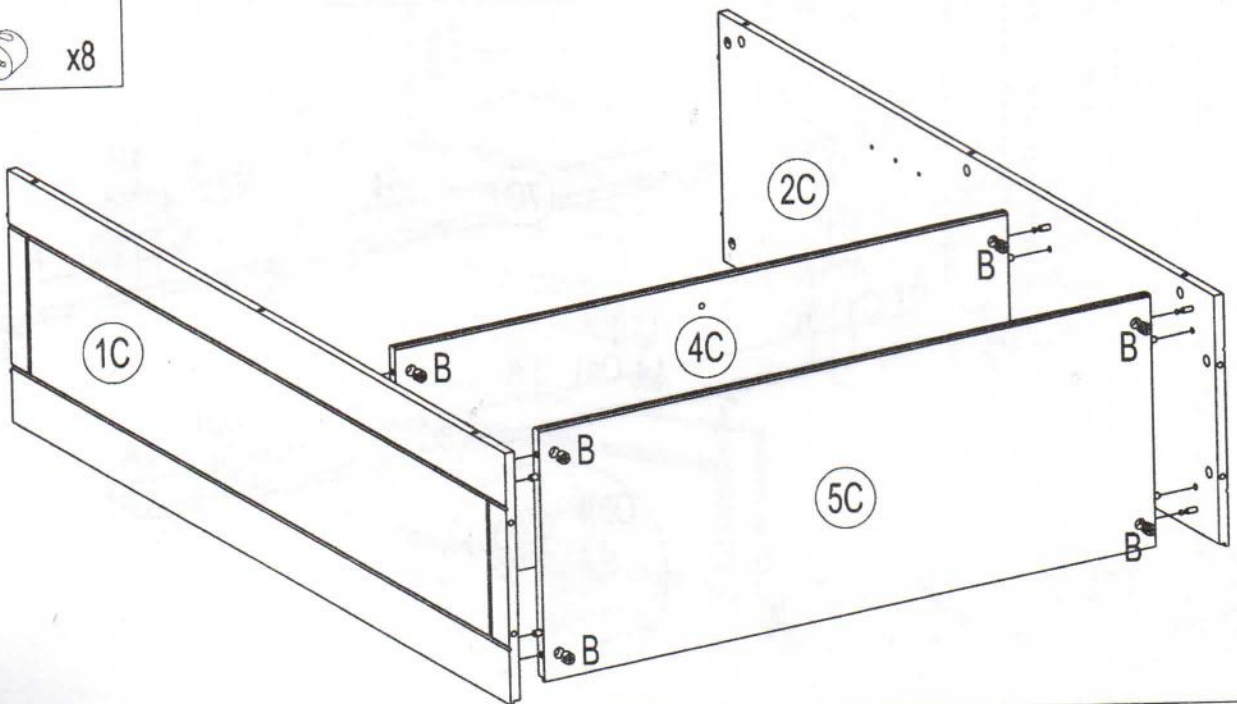
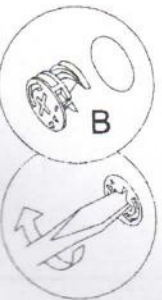
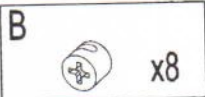

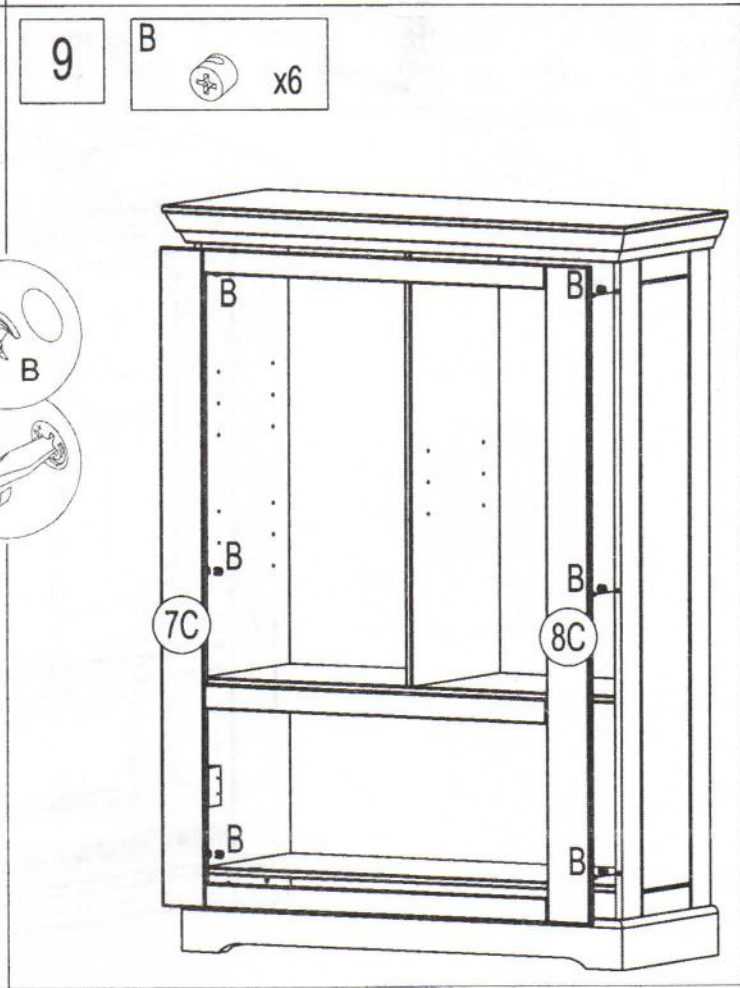
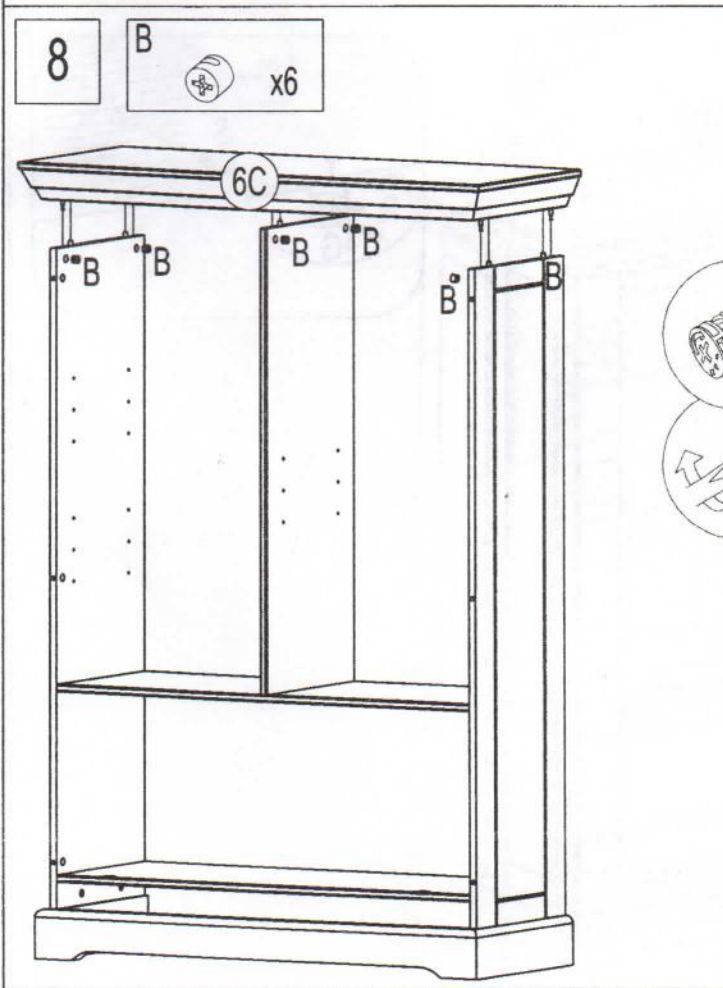
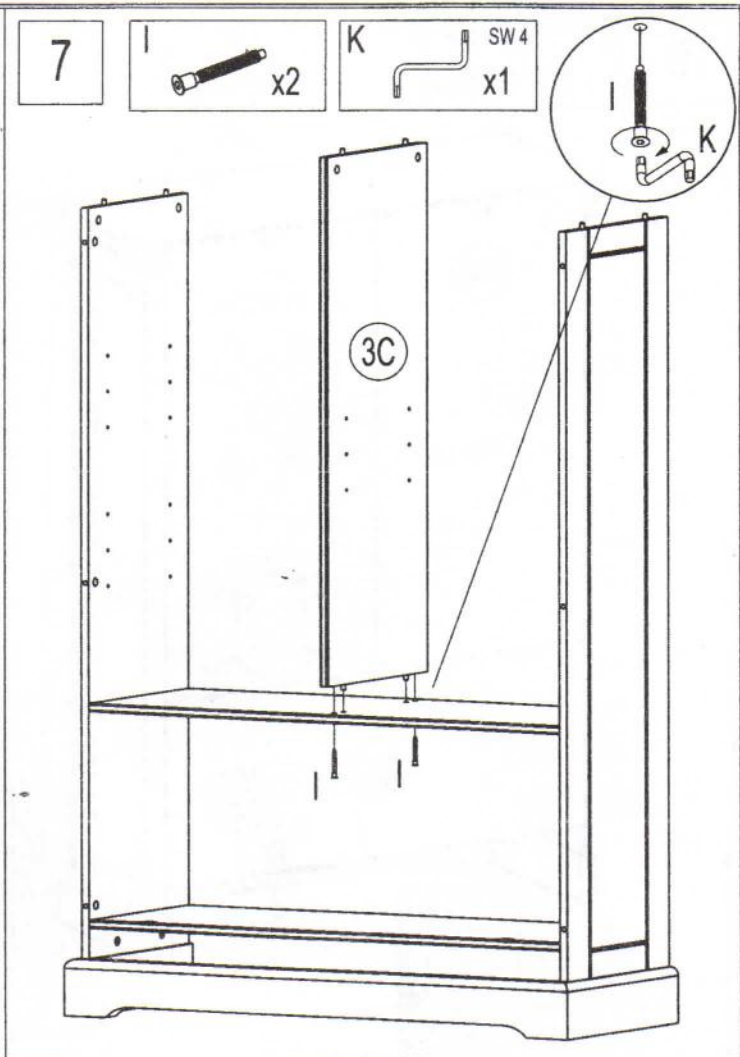
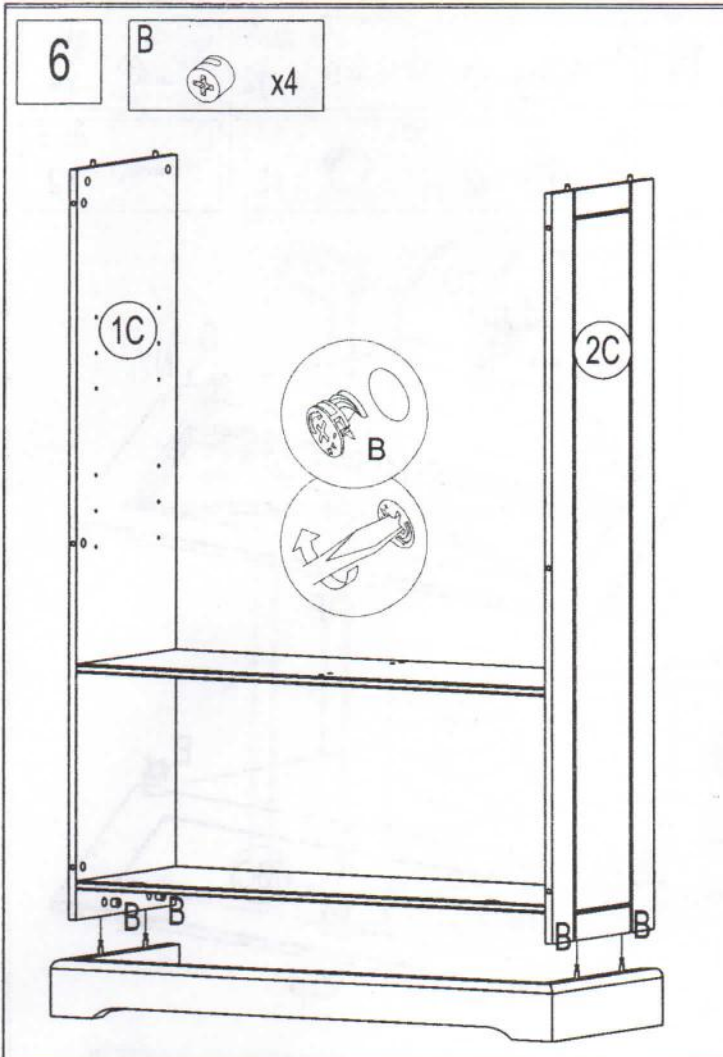

10

L 1.2x20
x75

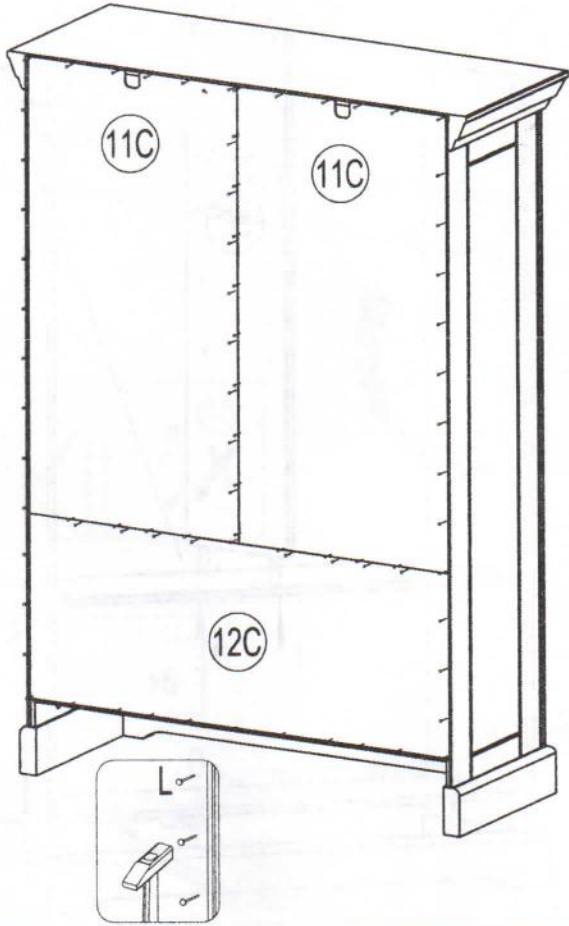

11

E x2

F 2.5x15
x12

G 3.5x15
x4

N x2

P x2

Q M4x22
x2

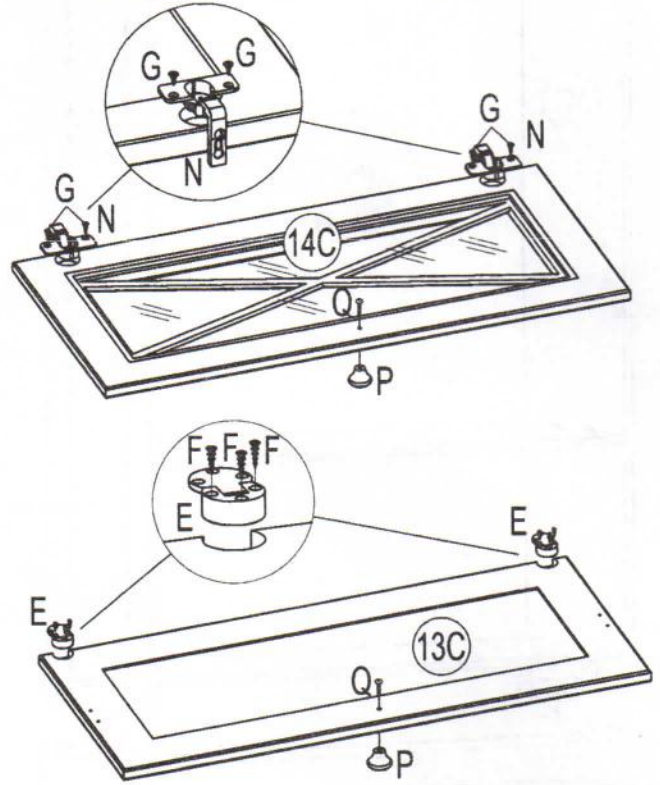

12

G 3.5x15
x2

R 5x50
x2

S 8x50
x2

T x2

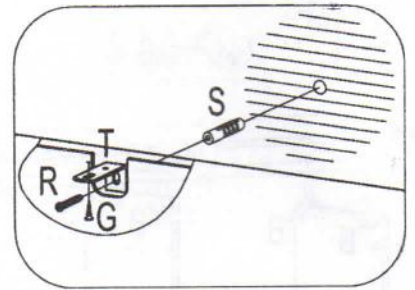
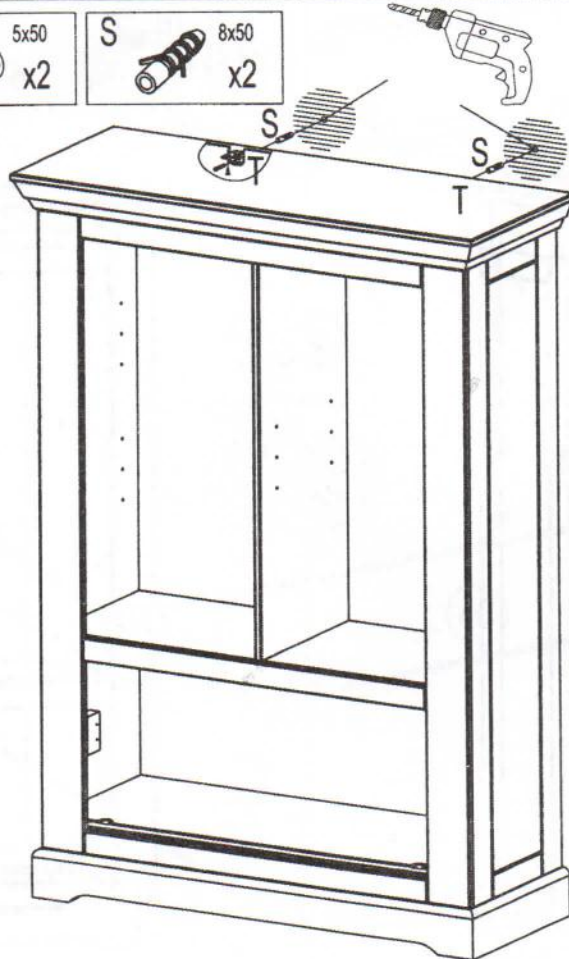

13

F



2.5x15
x6

G



3.5x15
x8

J



x2

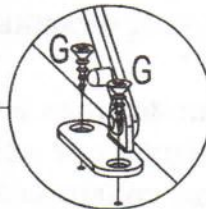
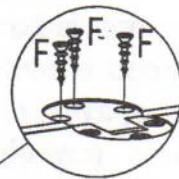
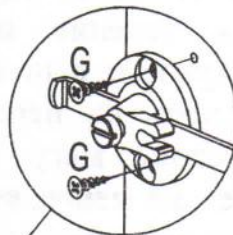
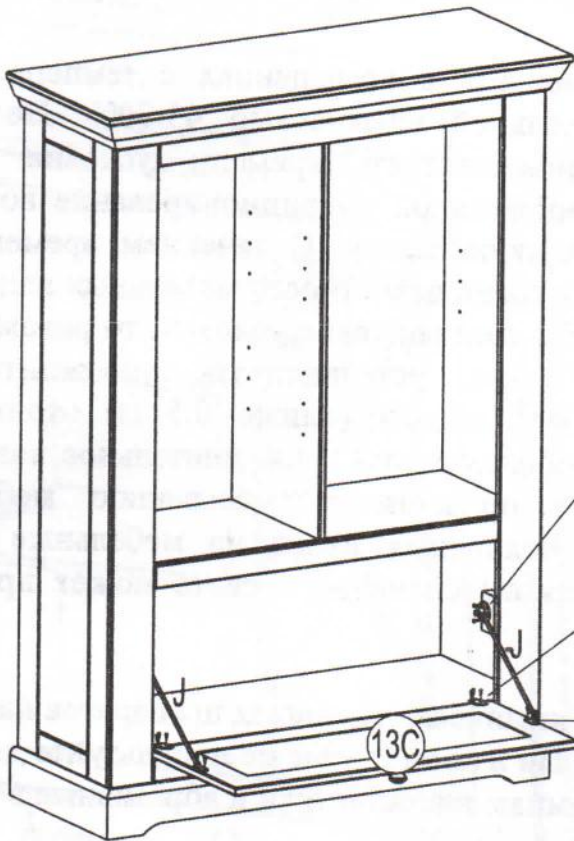

14

D



x12

